

SKILL LEVEL



ADVANCED  
BEGINNER

laid flat, beach  
bag/mat/towel  
measures  
52"/132cm  
wide and  
68"/173cm long

*www.hotpatterns.com*<sup>tm</sup>  
patterns so hot they're smokin'...

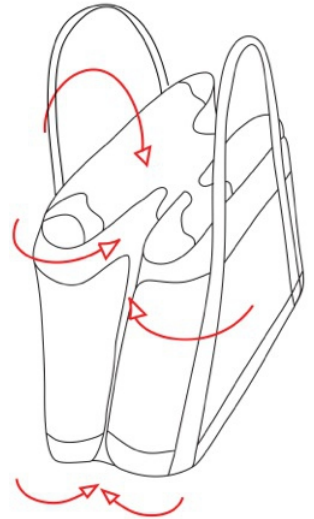
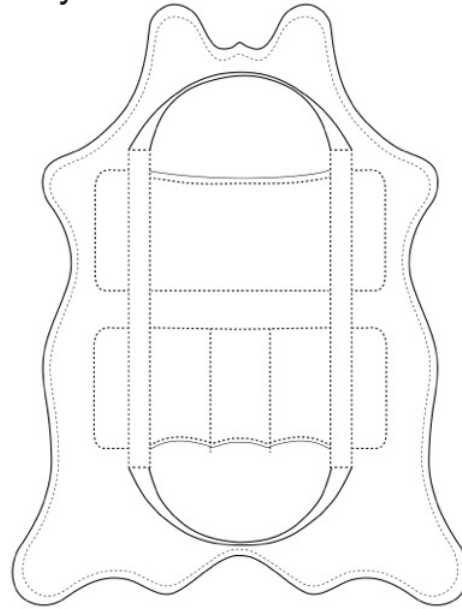

You'll certainly find a use for a super-useful, multi-purpose beach-bag-mat-towel combo, so make it a cool one like this! This glamour-packed piece needs two kinds of fabrics; fluffy toweling on the inside, and home-dec type fabrics like canvas, linen or broadcloth on the outside...try animal print for a super-chic version, or mix it up with a bright solid color, a groovy floral or a graphic print. Hide-shaped mat has a towel backing and folds up into a beach-bag; outer layer has pockets, shoulder straps and hook-and-loop fastened tabs that wrap around the sides to secure your beach essentials. Carry this to the pool, the beach, or the park for a super-stylish day out.

HotPatterns & fabric.com exclusive download  
Summer Safari Fold-up Beach-Bag/Mat/Towel

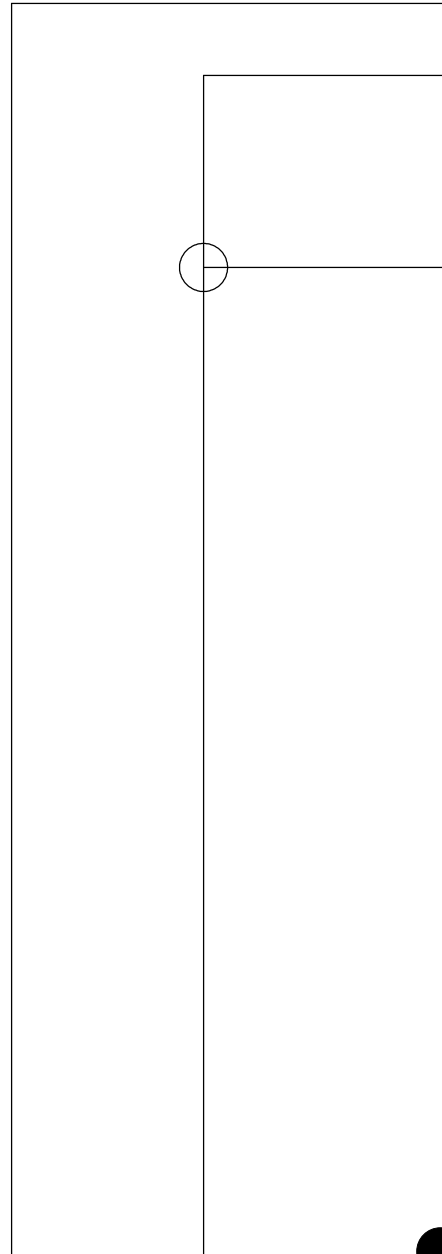
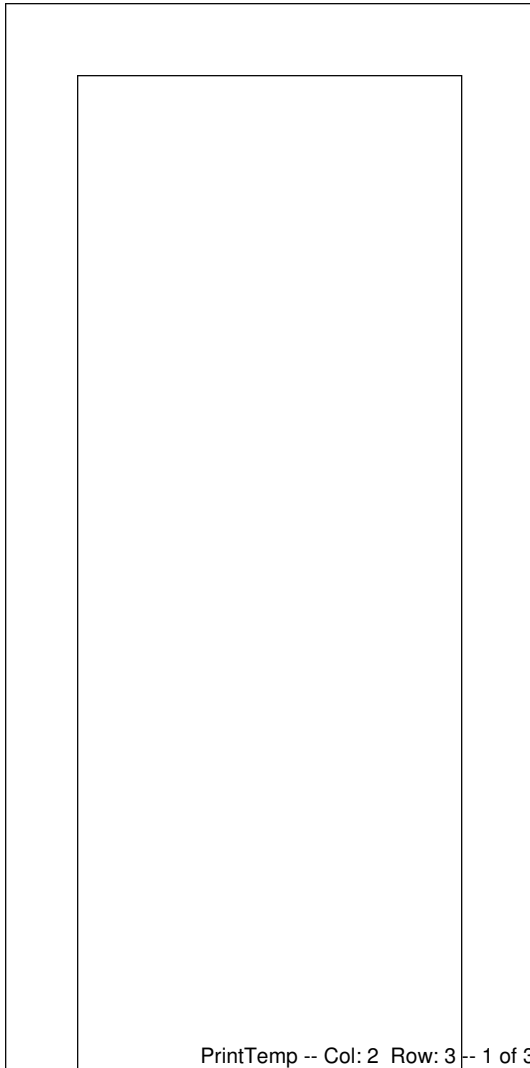

5

9

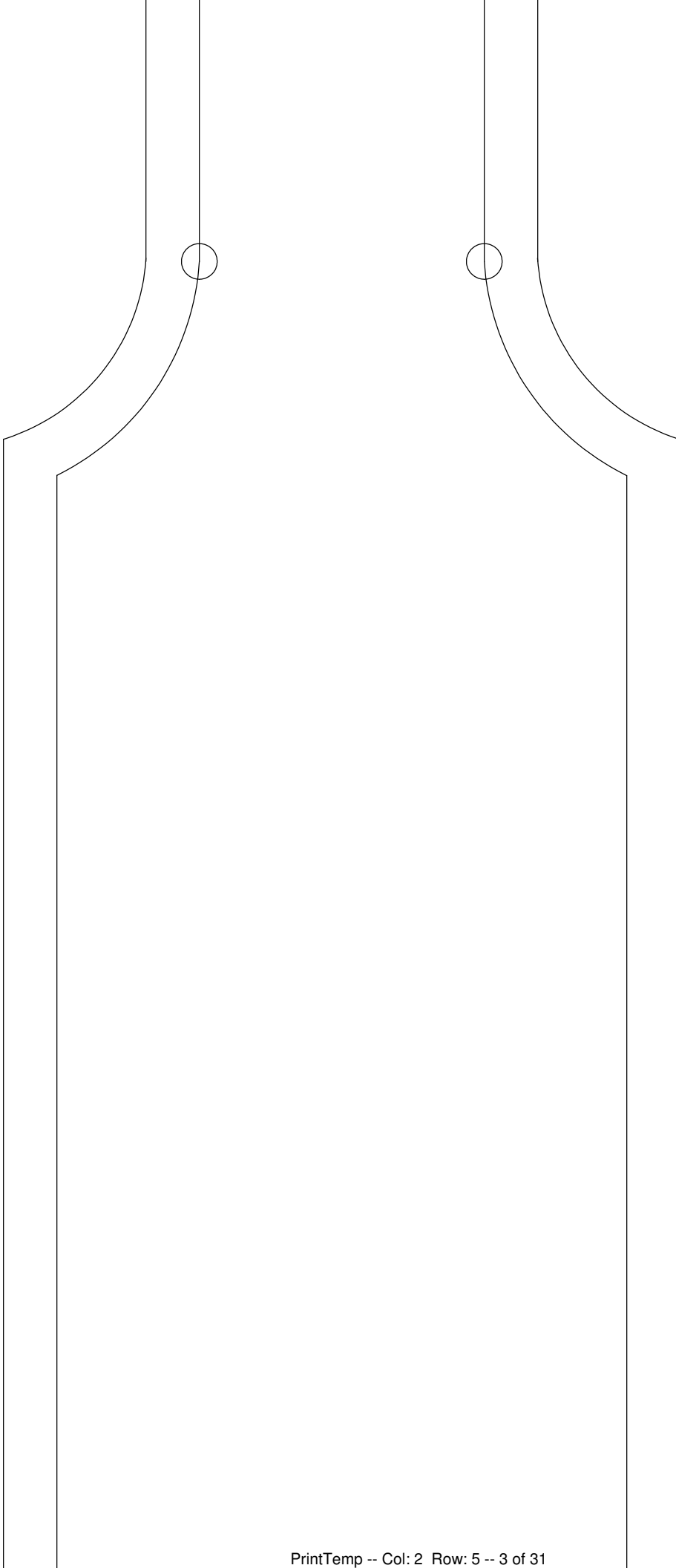

13

*Hot Patterns*

free download exclusively for

**fabric.com**

summer safari fold-up beach-bag/mat/towel  
handles

cut 1 pair in fabric

17

21

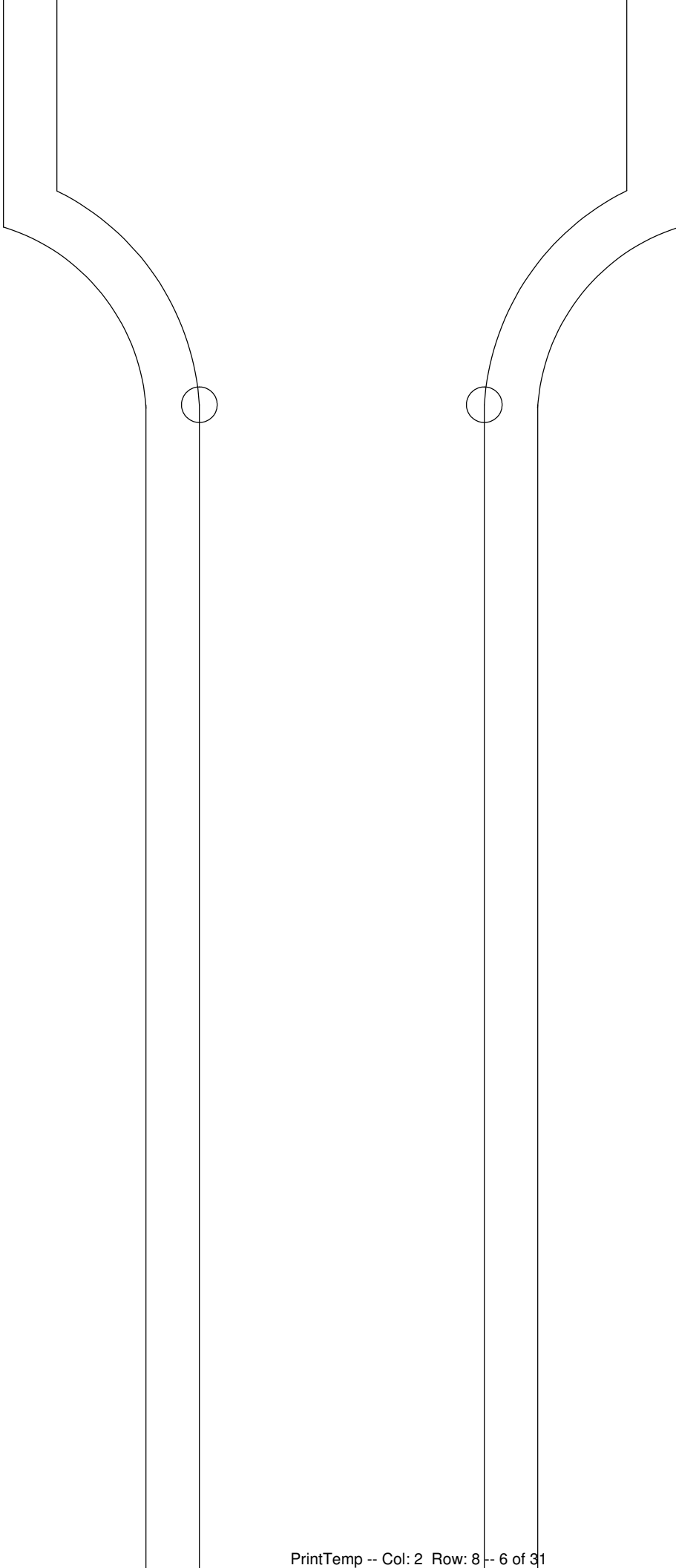

25

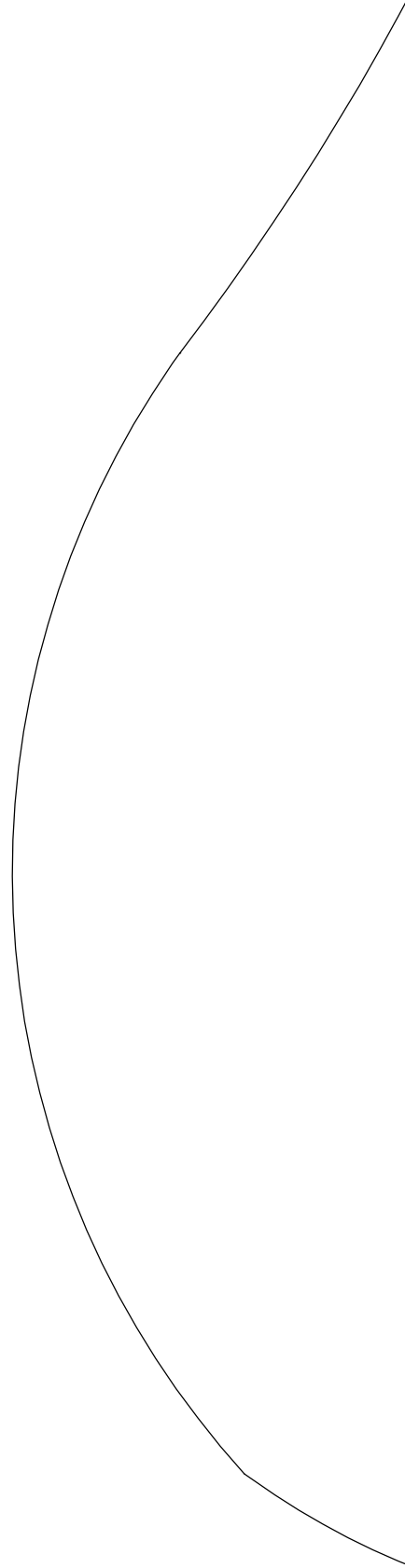
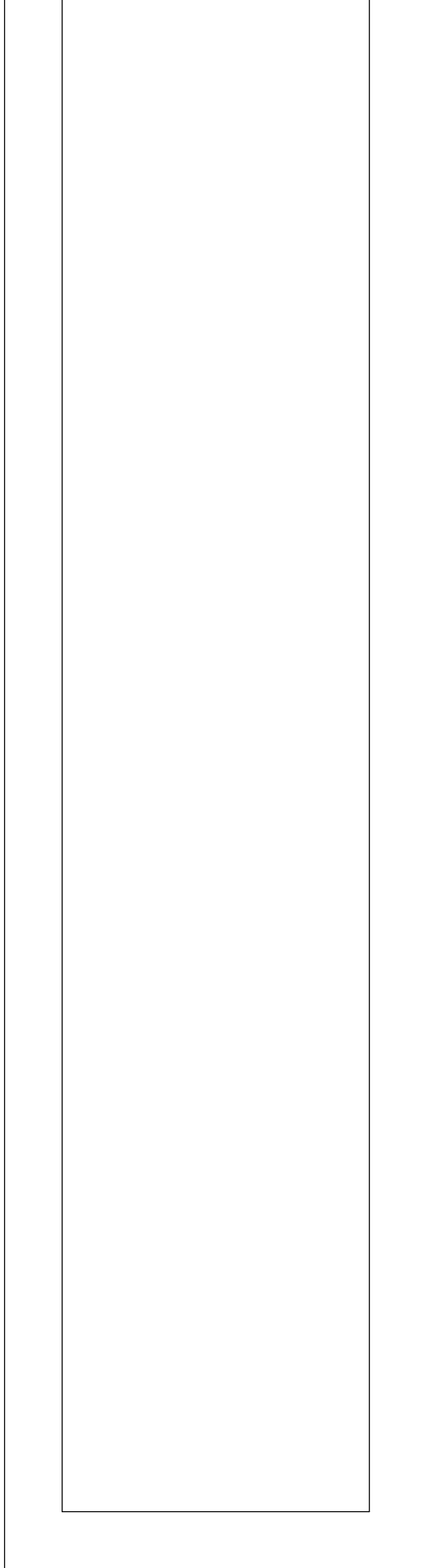



## exclusive free download summer safari fold-up beach-bag/mat/tote instructions page 1 of 3

### SEAM ALLOWANCES & OTHER INFO

Seam allowances are 5/8" wide; pocket hems and side seam allowances are 1" or 2.5cm deep. The outer edges of the mat are finished with made or purchased bias binding. All seams are sewn right sides together unless otherwise stated.

Skills needed include: making & attaching patch pockets; making & attaching hook & loop fastenings; making & applying handles; making & applying bias binding.

### ABOUT THIS STYLE

This beach mat folds up into a simple tote.  
It is suitable for all manner of fabrics, but please line the inside with a layer of toweling!

Don't bother making a muslin for this (as if you would!) but we do recommend that you read through these instructions carefully before you start cutting your fabric, just to see how it goes together.

### SUGGESTED TOWELING CUTTING LAYOUT

lay the toweling open for this layout.

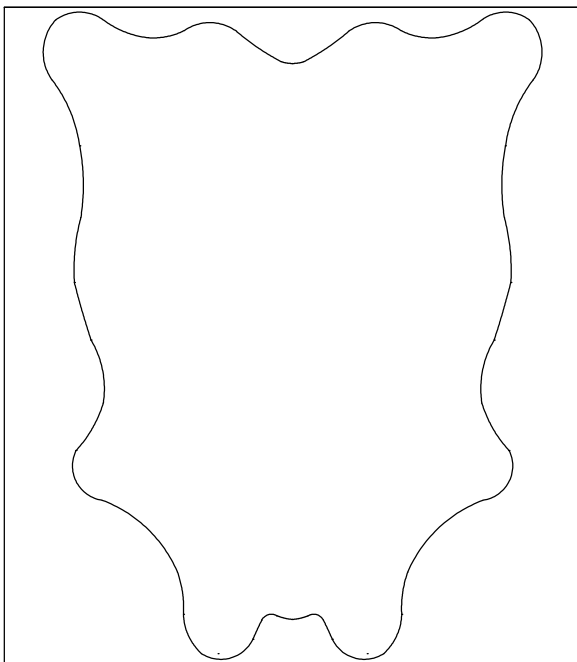

### SUGGESTED FABRIC CUTTING LAYOUT

lay the fabric open for this layout.

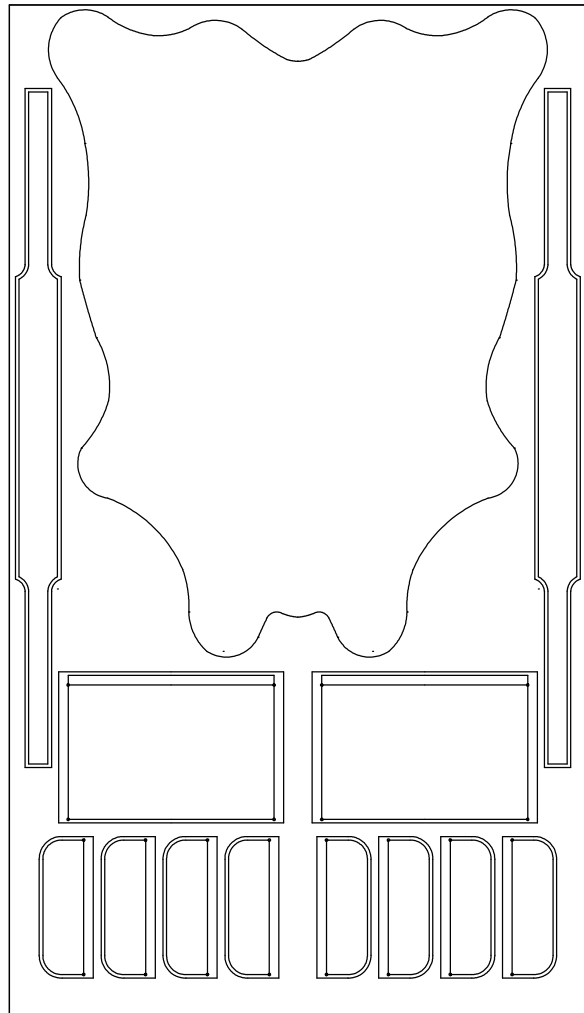

### FABRIC & NOTIONS REQUIRED

You'll need around 3 yards or 275 cm of 60"/150cm wide fabric, plus 2 yards or 183cm of toweling, any width from 52" or 132cm or wider.

If you want to make bias binding, add another 1/2 yard or 45cm of fabric; if you'd rather use purchased bias binding, you'll need 6.5 yards or 6m of 1"/2.5cm wide bias binding.

You'll also need 1 5/8 yard or 143cm of 1"/2.5cm wide hook & loop fastening.

2

*Hot Patterns*

free download exclusively for

**fabric.com**

summer safari

fold-up beach-bag/mat/towel

pockets

cut 1 pair on fold in fabric

---

6

10





18

22

26



# instructions page 2 of 3

**1a** Prepare & apply the pockets: start by finishing the top edges with a zig-zag stitch, overlocking or bias binding.

Press the top edges of the pockets under 1" or 2.5cm, then topstitch these hems into place. Press flat.

Press the bottom edges under 3/8" or 1cm, and press flat.

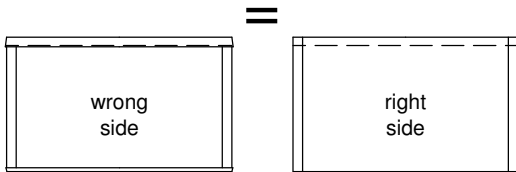
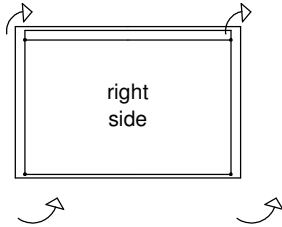

**1b** Following the position marks on the pattern, lay the pockets right sides up onto the FABRIC (not toweling) layer.

Pin or baste the pockets into place along the bottom and side edges.

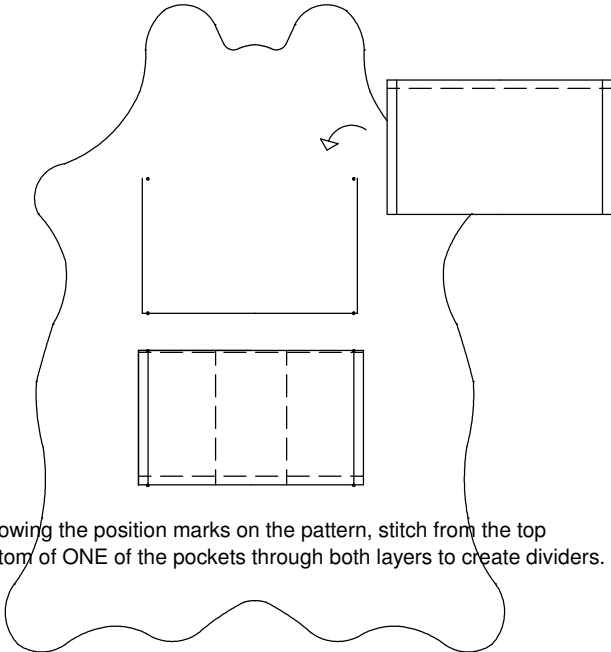

**1c** Following the position marks on the pattern, stitch from the top to the bottom of ONE of the pockets through both layers to create dividers.

**2a** Prepare & apply the side tabs: start by applying a strip of hook & loop closure to two pairs of the tab layers...see the pattern for the suggested position. Make sure that the top & bottom of each strip finishes longer than the tab.

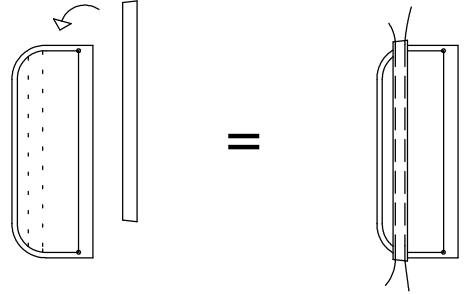

**2b** Right sides together, join one tab WITH the hook & loop strip to one tab WITHOUT the hook & loop strip, leaving the long straight edges open.

Clip the seam allowances, press them open and turn the tabs out.

Press flat; topstitch around the edges if you wish.

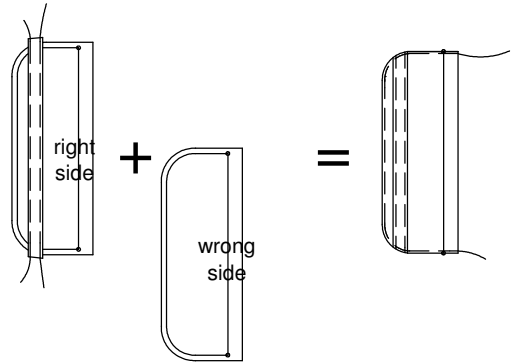

**2c** Following the position marks on the pattern, lay the tabs onto the FABRIC (not toweling) layer...their edges will butt up against the edges of the pockets you've already attached... baste the tabs into place along the long side edges.

PLEASE NOTE on one side the tabs will have the hooks facing down, the other side will have the loops facing up... otherwise the hook & loop won't work!

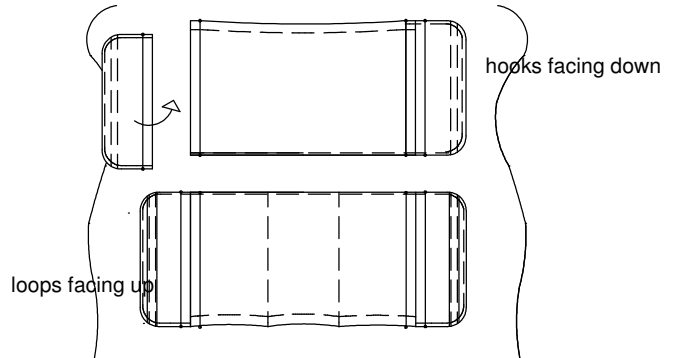

<<<APPLY YOUR HOOK

*Hot Patterns*

free download exclusively for

**fabric.com**

summer safari fold-up beach-bag/mat/towel  
side tabs

cut 4 pairs (total of 8) in fabric

**FOLD**

**7**

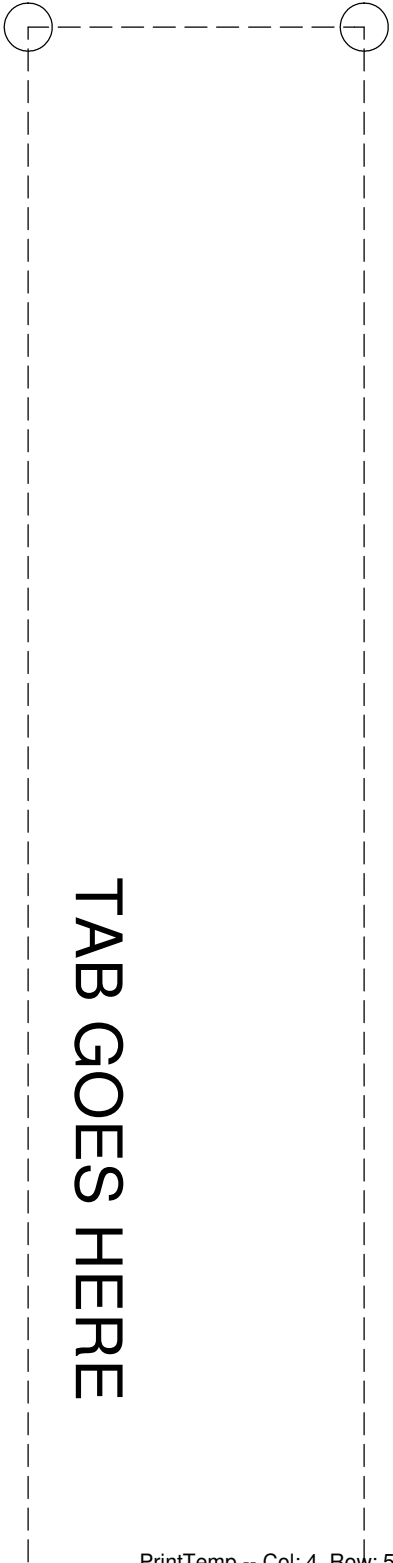



19



TAB GOES HERE

23

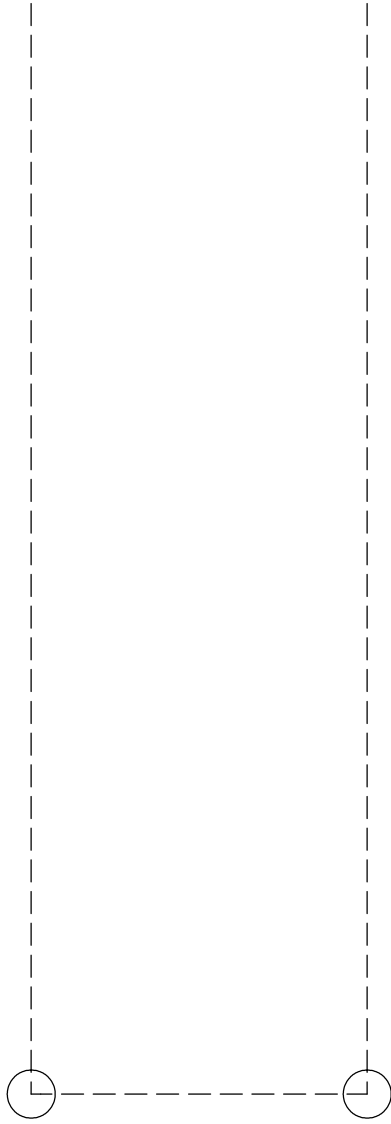



27



# instructions page 3 of 3

**3a** Prepare the handles...press the edges under 3/8" or 1 cm, like this...

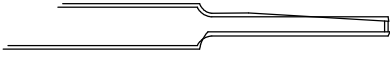

... then fold the handles in half lengthways  
RIGHT SIDES TOGETHER and join the edges of the  
center section.

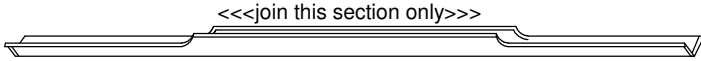

Press this seam open, then turn the handles out.

Press the handles flat, with the seam centered like this...

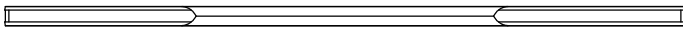

**3b** Join the handles together to create one long loop,  
then press the seams open.

**3c** Following the marks on the pattern and matching all  
drill holes, baste or pin the handles into place...  
the handles should cover the raw edges of the tabs and the pockets.

Topstitch the handles on.

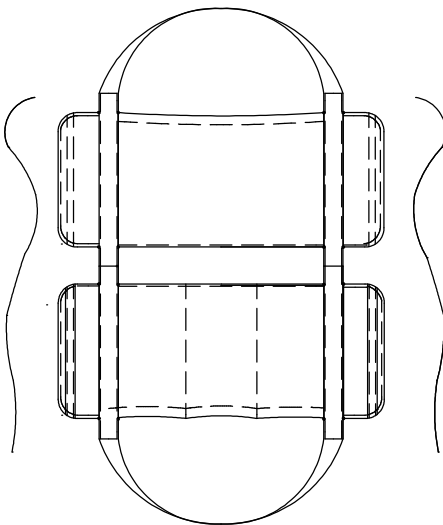

**4b** Using purchased or made bias binding, bind the edges of the  
towel-mat-tote.

If you need to make bias binding...cut some strips of fabric on the bias  
about 3" or 7.5cm wide. Join them together, and press the seams open,  
then EITHER pull the bias strips through a binding folder, pressing as  
you go, or press each edge to the center of the strip.

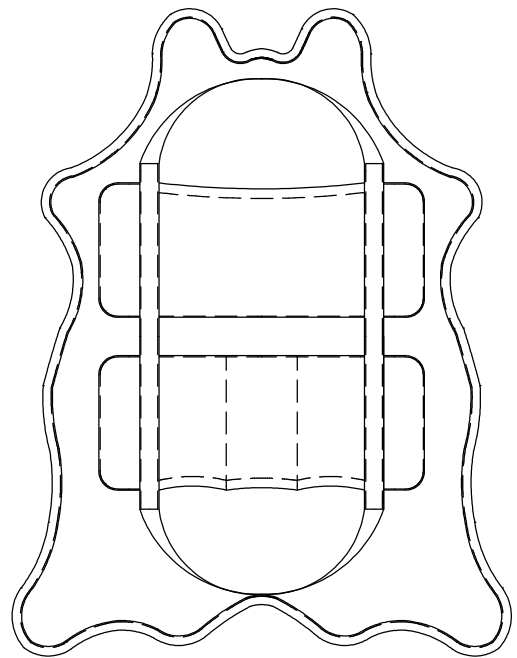
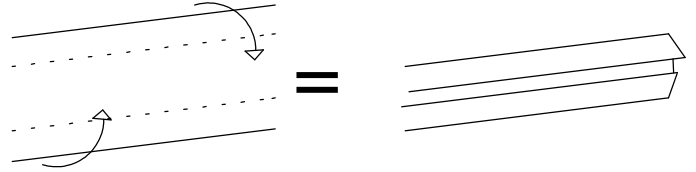

To fold the mat into a tote, flip the top edges down first,  
then fold in the sides, and secure the sides with the tabs. Voila!

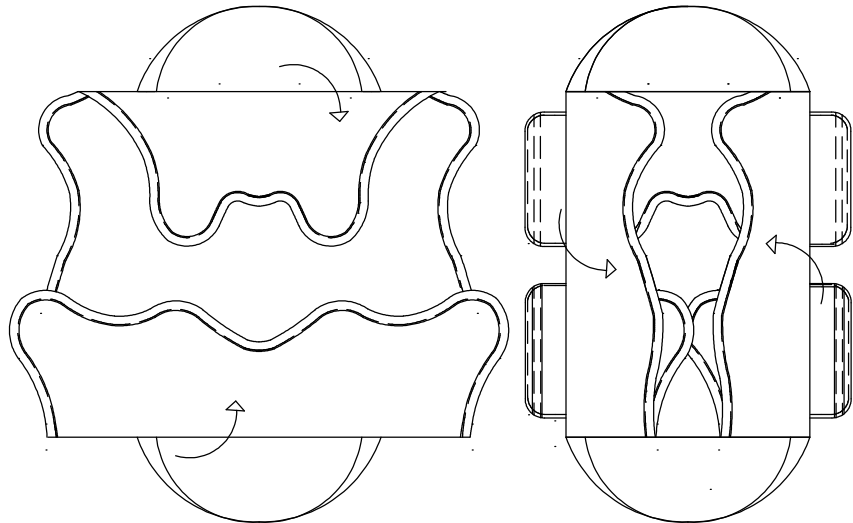

**4a** Time to assemble the towel-mat-tote...WRONG sides together,  
baste the fabric & toweling layers together around the edges.

4

< & LOOP STRIP HERE >>>



*Hot Patterns*

free download exclusively for

**fabric.com**

summer safari

fold-up beach-bag/mat/towel

mat/towel layer

cut 1 on fold in fabric

cut 1 on fold in toweling

8

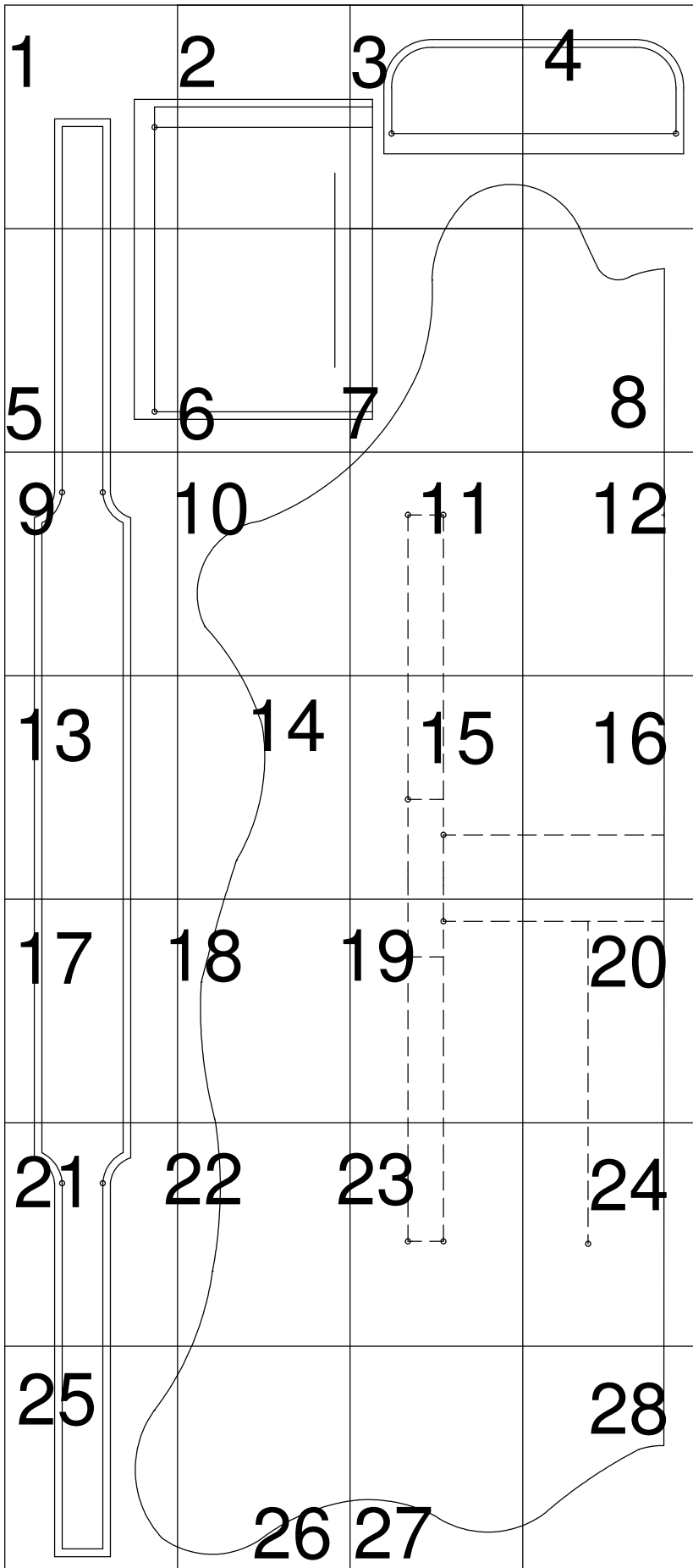

FOLD

12

FOLD



FOLD



